

MDM192

**MULTI-DROPS DIGITAL MODEM
FOR PRIVATE LINE**

USER GUIDE

Document reference : 9010709-03

**If you have questions about the MDM192
or desire assistance,
contact ETIC TELECOMMUNICATIONS at the following address :**

ETIC TELECOMMUNICATIONS

**13 Chemin du vieux chêne
38240 MEYLAN
FRANCE**

TEL : + 33 4 76 04 20 05

FAX : + 33 4 76 04 20 01

E-mail : hotline@etitelecom.com

web : www.etitelecom.com

**This user guide applies to the following product references with the
manufacturing index 07**

MDM192-0	Modem designed for 9 to 40 VDC supply voltage
MDM192-1	Modem designed for 40 to 60 VDC supply voltage

CONTENTS

1.	PRODUCT OVERVIEW.....	5
2.	NETWORK TOPOLOGIES	6
3.	MODEM PERFORMANCE.....	7
3.1.	Line characteristics.....	7
3.2.	Number of modems that can be connected to a line.....	7
3.3.	Range	7
4.	DESCRIPTION	9
4.1.	Leds.....	9
4.2.	DIP switches	10
4.3.	Connectors	12
5.	INSTALLATION	13
5.1.	Setting the data rate and the byte frame.....	13
5.2.	Matching the modem to the transmission line.....	14
5.3.	RS232 local interface	15
5.4.	RS485 / RS422 local interface	15
5.5.	Connection to the line : Point to point.....	16
5.6.	Connection to the line : Multidrop.....	17
5.7.	Test Frame	18

1. Product overview

The MDM192 modem provides half-duplex data transmission between PLCs (for instance), on a 2 wires cable over up to 30 Km.

Point to point or multi-drops transmission

16 PLCs (and even more) can be connected to the same line. (2 wires twisted and shielded pair) at a data rate up to 19200 b/s.

Reliability

The modems are connected in parallel to the line. If one modem fails, it does not prevent the rest of the network from transmitting normally.

Line isolation

The modem is isolated from the line through a 4000 VRMS transformer.

Local interface

The modem provides an RS232, RS422 and RS485 asynchronous interface.

The data rate ranges from 1200 to 19200 b/s (7 or 8 bits with or without parity, 1 start bit, 1 or 2 stop bits).

Transmission delay time

The digital technique used provides a very low delay of transmission (only 3 characters time).

Compatibility

The MDM 192 is able to transmit most PLC protocols among which :

Rockwell :	DF1, DH485
Siemens :	PROFIBUS DP
Schneider Electric :	MODBUS, UNITELWAY
Omron :	SYSMACWAY

... and generally speaking any master / slave asynchronous protocol.

2. Network topologies

Point to point

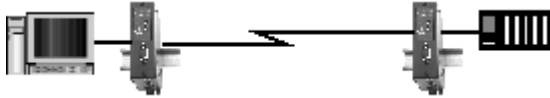

Bus

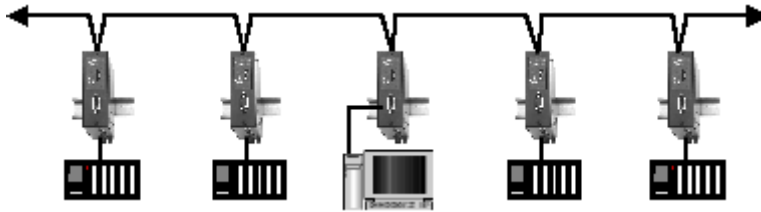

Star

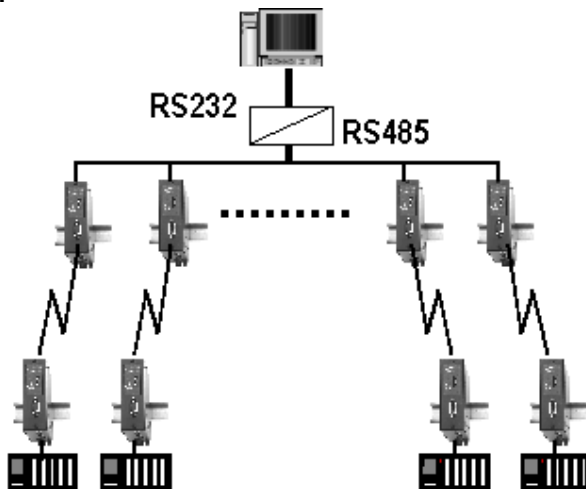

3. Modem performance

3.1. Line characteristics

The MDM 192 is designed to be connected to any 2 wires line; even if its diameter is very large or very small, and even if it is a coaxial cable.

However, the performance of the product is the best when it is connected to a twisted shielded pair.

3.2. Number of modems that can be connected to a line

Up to 16 modems can be connected to the same line. See table 1 below. If more than 16 modems have to be connected to the line, it will work properly but the range performance (whole length of the line) will decrease.

3.3. Range

The range (whole length of the line) depends upon the data rate, the line quality and the number of modems connected to the line .

If the line is noisy, the performances may decrease.

To increase the range, it is possible to repeat the data using the following design :

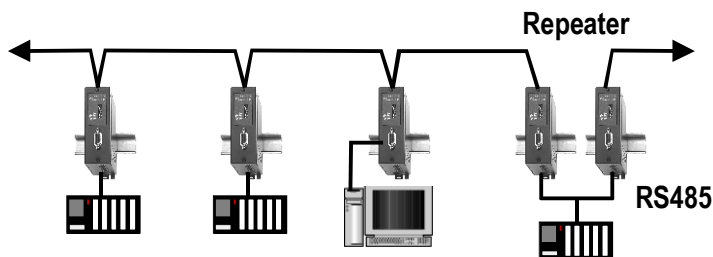

TABLE 1 : Range
Range with 2 modems connected to the line

	Cable diameter in mm (50 nF / km)				
Data rate	0,4	0,5	0,6	0,8	1
1200 b/s	13 km	16 km	20 km	26 km	34 km
2400 b/s	13 km	16 km	20 km	26 km	34 km
4800 b/s	13 km	16 km	20 km	26 km	34 km
9600 b/s	10 km	12 km	15 km	20 km	25 km
19200 b/s	6 km	7 km	9 km	12 km	15 km

Range with 8 modems connected to the line

	Cable diameter in mm (50 nF / km)				
Data rate	0,4	0,5	0,6	0,8	1
1200 b/s	12 km	14 km	18 km	24 km	29 km
2400 b/s	12 km	14 km	18 km	24 km	29 km
4800 b/s	12 km	14 km	18 km	24 km	29 km
9600 b/s	9 km	11 km	13 km	18 km	22 km
19200 b/s	5 km	6 km	7 km	10 km	12 km

Range with 16 modems connected to the line

	Cable diameter in mm (50 nF / km)				
Data rate	0,4	0,5	0,6	0,8	1
1200 b/s	11 km	13 km	16 km	22 km	26 km
2400 b/s	11 km	13 km	16 km	22 km	26 km
4800 b/s	11 km	13 km	16 km	22 km	26 km
9600 b/s	7 km	9 km	11 km	15 km	18 km
19200 b/s	4 km	5 km	6 km	9 km	11 km

4. Description

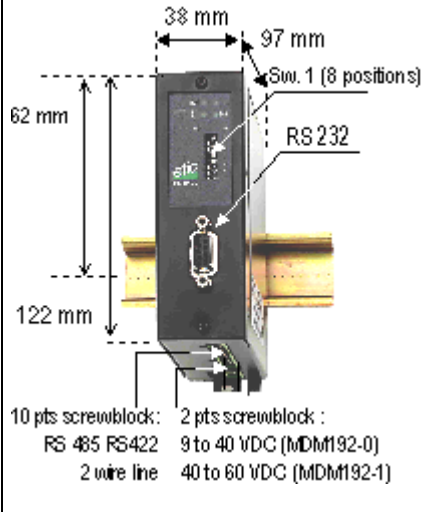
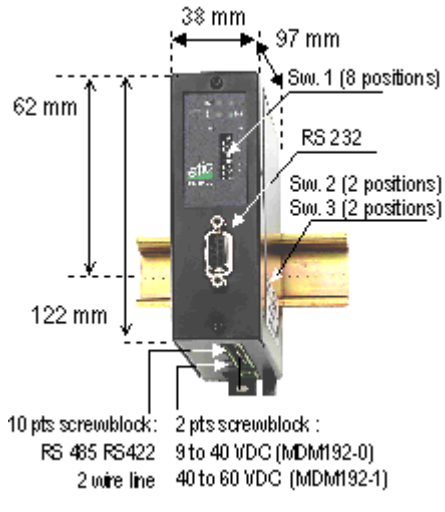
MDM192 Up to evolution index 8	MDM192 From evolution index 9
 <p>10 pts screwblock: RS 485 RS422 2 wire line</p> <p>2 pts screwblock : 9 to 40 VDC (MDM192-0) 40 to 60 VDC (MDM192-1)</p>	 <p>10 pts screwblock: RS 485 RS422 2 wire line</p> <p>2 pts screwblock : 9 to 40 VDC (MDM192-0) 40 to 60 VDC (MDM192-1)</p>

4.1. Leds

RD Data reception from the line

TD Data transmission to the line



Data reception errors

Test frame transmission (if SW1-8 is ON)
The led is blinking



Power supply

4.2. DIP switches

TABLE 2
SW1 DIP SWITCHES (8 positions)

FRAME	SW1-1
1 byte = 10 bits 8 b + start + 1 stop 7 b + parity + start + 1 stop 7 b + start + 2 stops	OFF
1 byte = 11 bits 8 b + parity + start + 1 stop 7 b + parity + start + 2 stops	ON

DATA RATE		SW1-2	SW1-3	SW1-7
19 200 b/s	For compatibility with evolution 01 to 06	OFF	OFF	OFF
19 200 b/s	Normal position	OFF	OFF	ON
9 600 b/s	For compatibility with evolution 01 to 06	OFF	ON	OFF
9 600 b/s	Normal position	OFF	ON	ON
4 800 b/s	For compatibility with evolution 01 to 06	ON	OFF	OFF
4 800 b/s	Normal position	ON	OFF	ON
2400 b/s		ON	ON	OFF
1200 b/s		ON	ON	ON

Reserved	SW1-4	SW1-5	SW1-6
Mandatory	OFF	OFF	OFF

TEST	SW1-8
Test Frame transmission	ON
Normal operation	OFF

TABLE 3 : SW2 DIP SWITCHES
Adapting the modem to the line quality, if necessary

From the 9 evolution index only				
Line impedance	Output R	SW2- 1	SW2-2	
>350	540 Ohm	OFF	OFF	Default position
270 < Zc < 350	420 Ohm	ON	OFF	
190 < Zc < 270	270 Ohm	OFF	ON	
Zc < 190	150 Ohm	ON	ON	

TABLE 4 : SW3 DIP SWITCHES
Selecting the value of the line matching Resistor

From the 9 evolution index only				
Line impedance	Matching R	SW3-1	SW3-2	
> 350	390 Ohm	OFF	OFF	Default position
270 < Zc < 350	310 Ohm	ON	OFF	
190 < Zc < 270	230 Ohm	OFF	ON	
Zc < 190	150 Ohm	ON	ON	

Any modification of the dip switches position operates immediately.

4.3. Connectors

TABLE 5 : 10 points screw block Line and local RS485 and RS422 interface		
Pin Nr	Signal	Function
Line		
1	L1	Line signal wire 1
2	L2	Line signal wire 2
3	Adp	Line adaptation bridging points 2 and 3
4	-	NC
5	-	NC
6	-	NC
Local RS485 and RS422 interface		
7	RS422 B'	RS422 Transmission polarity B (to MDM192)
8	RS422 A'	RS422 Transmission polarity A (to MDM192)
9	RS485 B	RS422 Reception polarity B (to the local data terminal) or RS485 polarity B
10	RS485 A	RS422 Reception polarity A (to the local data terminal) or RS485 polarity A

TABLE 6 : DB9 fem. RS232 CONNECTOR Not isolated local Interface				
Pin Nr	Circuits		Designation	Terminal-Modem
1	CD	109	Carrier detect	←
2	RX	104	Data reception	←
3	TX	103	Data emission	⇒
4	DTR	108	Data terminal ready	⇒
5	SG	102	Signal ground	
6	DSR	107	Data set ready	←
7	RTS	105	Request to send	⇒
8	CTS	106	Clear to send	←
9	RI	125	Ring indicator	←

TABLE 7 : 2 pins screw-block Supply voltage !! CHECK THE PRODUCT REFERENCE ON THE RIGHT SIDE OF THE PRODUCT		
Pin Nr	Signal	Function
1	+	9 to 40 VDC supply voltage for reference MDM192-0 40 to 60 VDC supply voltage for reference MDM192-1
2	-	Signal ground

5. Installation

5.1. Setting the data rate and the byte frame

The MDM192 modem does not adapt the data rate between the line and the serial interface (RS232 or RS485 or RS422); it transmits at the same data rate over the line and over the serial interface.

Byte frame

The switch Nr 1 of the SW1 block must be set OFF or ON according to the number of bits of each byte (10 or 11 bits); see table 2.

Data rate

The switches Nr 2 and 3 and 7 of the SW1 block must be set in the position corresponding to the data rate in use.

5.2. Matching the modem to the transmission line

This paragraph applies to the products the evolution index of which is 9 or higher (see the identification label on the side of the product).

It describes how to adapt the modem to the characteristics of the line, using the SW2 and SW3 switches blocks, to get the best possible transmission distance.

The SW2 and SW3 switches blocks are located on the side of the product.

The products the evolution index of which is 9 or higher, are fully compatible with older products (index 8 or lower); in that case, all the switches of the SW2 and SW3 switches blocks (on the side of the product) have to be left OFF.

Principle

The SW2 and SW3 switches blocks have to be set according to the characteristics of the line represented by the line impedance (Z_c).

The line impedance Z_c can be calculated as follows :

$Z_c = \text{square root } [2 \times R/C\omega]$ with

R= Wire resistance (Ohm / Km)

C = Mutual capacitance between the wires (Farad / Km)

ω = Signal pulsation ($6,28 \times F$)

To avoid calculations, refer to table 8 just below.

TABLE 8 : Line impedance / wire diameter and cable mutual capacitance									
Wire diameter	mm	0,4	0,4	0,6	0,6	0,8	0,8	1	1
Mutual capacity	nF/ km	50	100	50	100	50	100	50	100
Z_c at 1200 or 2400 or 4800 b/s		578	408	385	272	289	204	231	163
Z_c at 9600 b/s		408	289	272	193	204	144	163	116
Z_c at 19200 b/s		289	204	193	136	144	102	116	82

SW2 and SW3 switches blocks setting

All the modems connected to the same line have to be set identically.

Set the switches according to the table 9 below.

TABLE 9 : SW2 and SW3 setting				
Line impedance	Output R		Value of the matching R	
Ohm	SW 2-1	Sw2-2	SW3-1	SW3-2
>350	OFF	OFF	OFF	OFF
$270 < Z_c < 350$	ON	OFF	ON	OFF
$190 < Z_c < 270$	OFF	ON	OFF	ON
$Z_c < 190$	ON	ON	ON	ON

5.3. RS232 local interface

The RS232 interface is available on the DB9 connector on the front panel.

The data terminal must be less than 10 meters far from the modem.

The connection to a PC is achieved with a straight cable (1 to 1, 2 to 2 etc...)

5.4. RS485 / RS422 local interface

The RS422 and RS485 interfaces are available on the 10 pts screw block.

Up to 16 data terminals can be connected to the local RS485 bus.

The data terminals must be less than 100 meters far from the modem.

- RS485 / RS422 polarization

The MDM 192 includes line polarization resistors.

- RS485 / RS422 line adaptation

For a several meters long connection over the RS485 local interface, it is not necessary to adapt the RS485 line.

For longer distances, connect a 120 Ohm resistor at each end of the line.

5.5. Connection to the line : Point to point

The line matching resistors have to be connected in each modem by bridging pts 2 and 3 of the 10 pts screw block

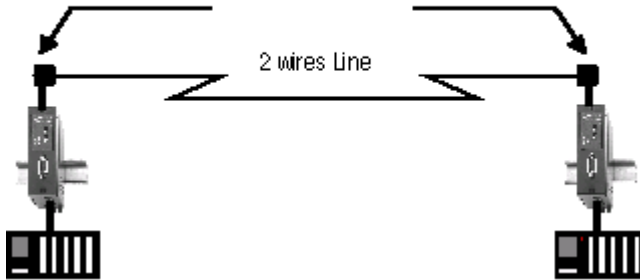

Line connection

The line has to be connected to the 10 points screw block points 1 and 2
The wires can be inverted.

The MDM192 includes the line adaptation resistor.
It has to be brought into service at each end of the line by bridging points 2 and 3 of the 10 pins screw block

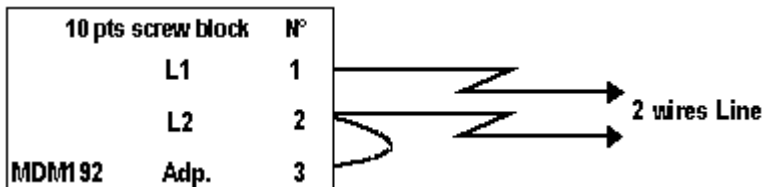

Shield

If the cable is shielded, the shield must be connected to the protective earth pin available at the bottom of the product.

5.6. Connection to the line : Multidrop

The line matching resistor has to be brought into service in each modem located at the end of the line by bridging pts 2 and 3 of the 10 pts screw block

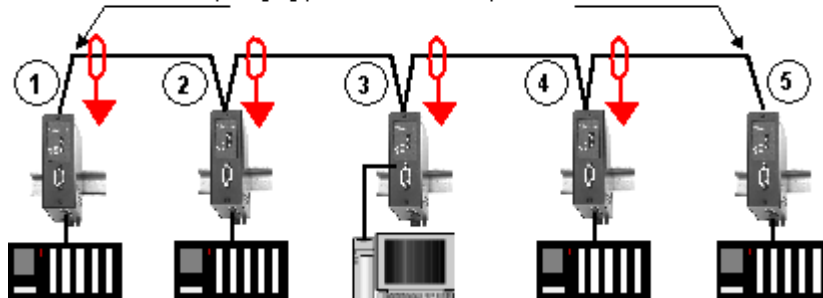

Connecting to the line the modems located at each end (modems 1 and 5 of the drawing above) :

The 2 wires of the line have to be connected to the 10 points screw block points 1 and 2. The wires can be inverted.

The MDM192 includes the line adaptation resistor.

It has to be brought into service in each modem located at the end of the line by bridging points 2 and 3 of the 10 pins screw block

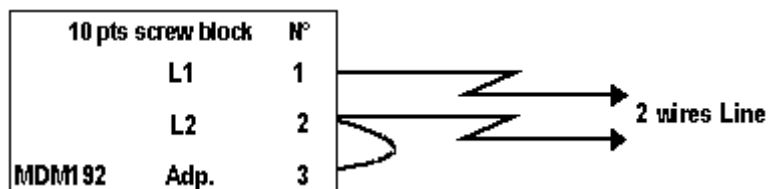

Shield :

If the cable is shielded, the shield must be connected to the protective earth pin available at the bottom of the product.

Connecting to the line a modem not located at the end of the line (modems 2 to 4 of the drawing above) :

The 2 wires of the line have to be connected to the points 1 and 2 of the 10 points screw block. The wires can be inverted.

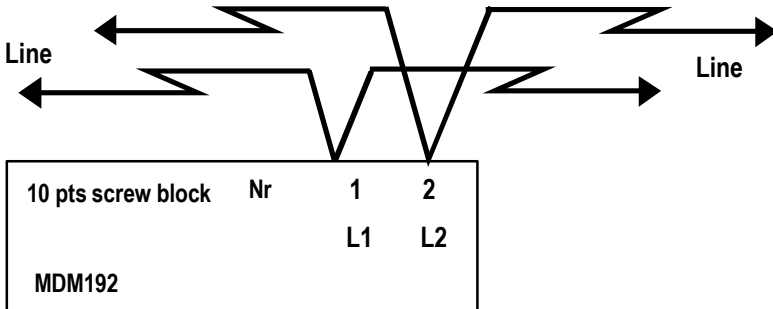

Shield

If the cable is shielded, the shield must be connected to the protective earth pin available at the bottom of the product.

5.7. Test Frame

For test purposes, the MDM 192 is able to transmit permanently a character frame. That function is available only if the data rate is set at a value from 4800 to 19200 b/s. To enable the test function, set to ON the switch Nr8 of the SW1 switches block (SW1-8) located on the front side of the product.

The red led blinks each time a test frame is transmitted.

The test frame is transmitted at the data rate which has been set, **but any case with 1 stop and no parity (8N1).**

The frame can be displayed with a PC using the ModemView software (Copyright ETIC), or any terminal emulation software.

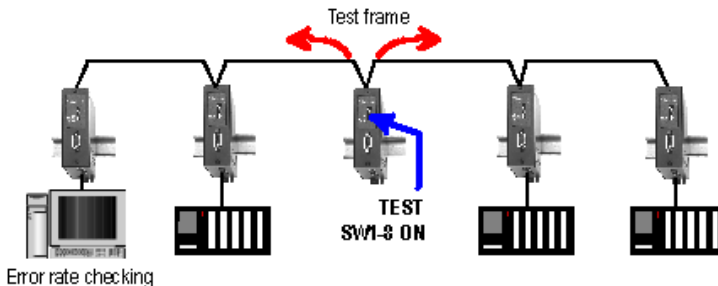

CARACTERISTICS	
Local Interface	RS485 - RS422 - RS232
Data	Asynchronous : 7 or 8 bits Parity : none / even / odd 1 start, 1 or 2 stops 1200 - 2400 - 4800 – 9600 - 19200 b/s
Range (informative value)	Up to 30 Km
Configuration	8 DIPswitches
Size	115 x 38 x 96 mm (h, l, p)
Isolation from the line	Transformer : 4000 Vrms
EMC	EN50082-2
Security	EN 60950
Thunder	EN61000-4 et -5
Supply voltage	9 to 40 VDC reference MDM192-0 40 to 57 VDC reference MDM192-1
Power consumption	80 mA - 24 VDC
Operating T°	-20°C / + 60°C (dry air)



13, Chemin du Vieux Chêne

38240 Meylan France

Tél : 04 76 04 20 00

Fax : 04 76 04 20 01

E-mail : info@etictelecom.com

Web : www.etictelecom.com